

2022

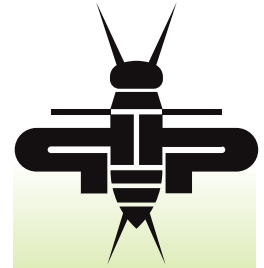

Grillo

AGRIGARDEN
MACHINES



G Z1 - G Z2









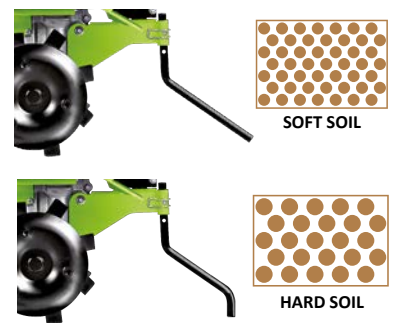
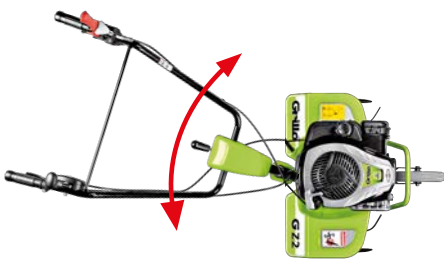





G Z1











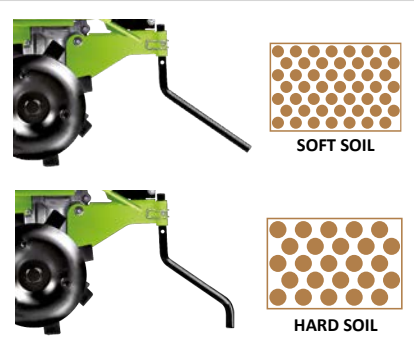



G Z2



										
	575 EX B&S	HP 3 - kW 2.2	140/1	0,8 (0.84) L (US qts)		155 rpm	--	A 28 cm (11 in)	52 cm (20 in)	35 (77)
G Z1										
G Z2						155 rpm	Max 2,1 km/h (1.3 mph)	A 28 cm (11 in)	52 cm (20 in)	41 (90)

G Z3



										
	HP-kW	CC	L (US qts)					A		kg (lb)
G Z3	GCV 170 Honda	HP 4.8 - kW 3.6	166/1	0,9 (0.95)		155 rpm	Max 2,1 km/h (1.3 mph)	A 28 cm (11 in)	75 cm (29.5 in)	45 (99)

PRINCESS

M1 - MR



PRINCESS MR



PRINCESS M1

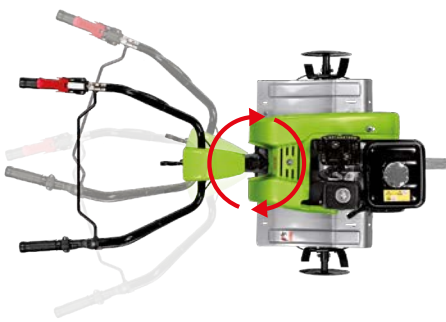

		HP-kW	CC	L (US qts)						kg (lb)
M1	G 200 FA Loncin	HP 5.5 - kW 4.1	196/1	3 (3.2)		① 132 rpm	--	A 32 cm (12 in)	30-52-77 cm (12-20-30 in)	62 (137)
MR	G 200 FA Loncin	HP 5.5 - kW 4.1	196/1	3 (3.2)		① 132 rpm	Max 2,3 km/h (1.4 mph)	A 32 cm (12 in)	30-52-77 cm (12-20-30 in)	64 (141)
	GX 200 Honda	HP 5.5 - kW 4.1	196/1	3,1 (3.3)						62 (137)

PRINCESS

MP3 - MP3 PRO



PRINCESS MP3



PRINCESS MP3 PRO

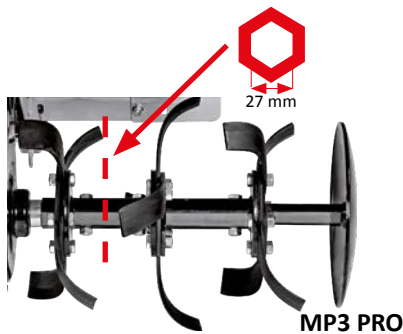

MP3 PRO



MP3









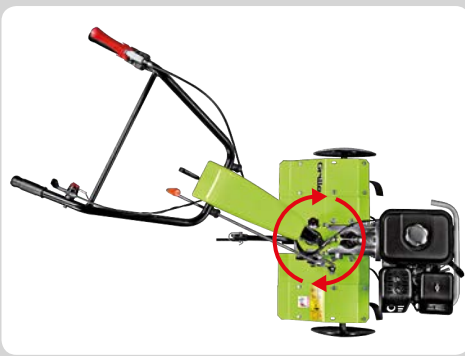

MP3 LABOUR KIT

		HP-kW	CC	L (US qts)						kg (lb)
MP3	G 200 FA Loncin	HP 5.5 - kW 4.1	196/1	3 (3.2)		36 rpm 160 rpm	Max 2,3 km/h (1.4 mph)	A 32 cm (12 in)	30-52-77 cm (12-20-30 in)	65 (143)
MP3 PRO	G 200 FA Loncin	HP 5.5 - kW 4.1	196/1	3 (3.2)		36 rpm 160 rpm	Max 2,3 km/h (1.4 mph)	A 33 cm (13 in)	56-82 cm (22-32 in)	66 (145)
	GX 200 Honda	HP 5.5 - kW 4.1	196/1	3,1 (3.3)		36 rpm 160 rpm	Max 2,3 km/h (1.4 mph)	A 33 cm (13 in)	56-82 cm (22-32 in)	66 (145)

3500



										
3500	G 200 FA Loncin	HP 5.5 - kW 4.1	196/1	3 (3.2)			Max 3 km/h (1.8 mph)	A 32 cm (12 in)	58-85-111 cm (23-33-43 in)	81 (179)
	GX 200 Honda	HP 5.5 - kW 4.1	196/1	3,1 (3.3)						79 (174)

11500

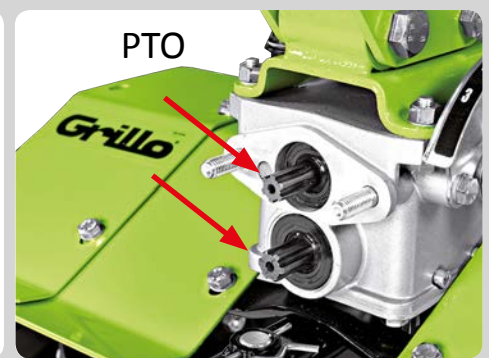
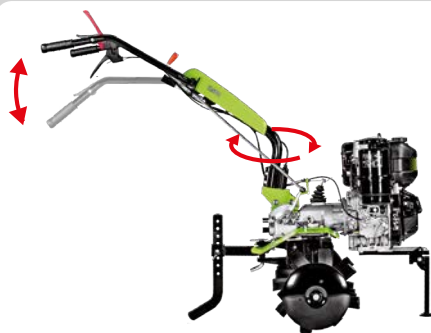

		HP-kW	CC	 L (US qts)						 kg (lb)
11500	G 300 FA Loncin	HP 9.3 - kW 6.8	302/1	6,1 (6.4)		① 53 rpm ② 123 rpm ③ 162 rpm	Max 3 km/h (1.8 mph)	A 33 cm (13 in)	59-86-112 cm (23-34-44 in)	92 (203)
	GX 270 Honda	HP 8.4 - kW 6.3	270/1	5,3 (5.6)						90 (198)
	KD15 350 Kohler	HP 7.5 - kW 5.5	349/1	Diesel 4,3 (4.5)						110 (242)
										121 (267)

G 45

COUNTER-ROTATING TILLER















		HP-kW	CC	 L (US qts)						 kg (lb)
G 45	G 200 FA Loncin	HP 5.5 - kW 4.1	196/1	3 (3.2)						82 (181)
					4.00-8 1,6 km/h (1 mph) →	4.00-8 2,5 km/h (1.5 mph) ←	A 26 cm (10 in)	50 cm (20 in)		

G 46









COUNTER-ROTATING TILLER



										
G 46	GX 200 Honda	HP 5.5 - kW 4.1	196/1	3,1 (3.3)		 4.00-8 1,6 km/h (1 mph) →	 4.00-8 1,6 km/h (1 mph) ←	A 26 cm (10 in)	50 cm (20 in)	98 (216)

G 52















		HP-kW	CC	 L (US qts)						 kg (lb)
G 52	G 200 FA Loncin	HP 5.5 - kW 4.1	196/1	3 (3.2)		13x5.00-6	13x5.00-6	A 26 cm (10 in)	37-50 cm (15-20 in)	67 (148)
						1,4 km/h (0.9 mph)	2,2 km/h (1.4 mph)			
						2,2 km/h (1.4 mph)	1,4 km/h (0.9 mph)			

G 55



LABOUR KIT

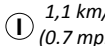
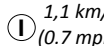

		HP-kW	 CC	 L (US qts)						 kg (lb)
G 55	3000 Serie Kohler	HP 5.5 - kW 4.1	196/1	3,6 (3.8)		 4.00-8 ⓘ 1,1 km/h (0.7 mph) Ⓜ 2,6 km/h (1.6 mph)	 4.00-8 ⓘ 1,1 km/h (0.7 mph) Ⓜ 2,6 km/h (1.6 mph)	A 26 cm (10 in)	58 cm (23 in)	86 (189)
	GX 200 Honda	HP 5.5 - kW 4.1	196/1	3,1 (3.3)		 4.00-8 ⓘ 1,1 km/h (0.7 mph) Ⓜ 2,6 km/h (1.6 mph)	 4.00-8 ⓘ 1,1 km/h (0.7 mph) Ⓜ 2,6 km/h (1.6 mph)			87 (192)

G 84



FORWARD AND COUNTER-ROTATING TILLER

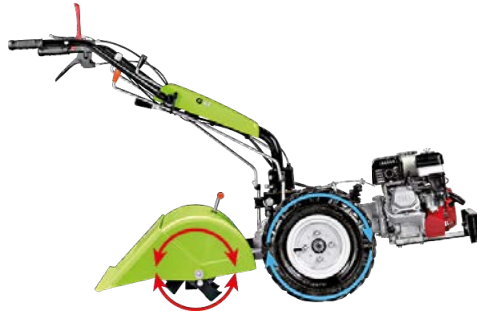

		HP-kw	CC	 L (US qts)						
G 84	GX 200 Honda	HP 5.5 - kW 4.1	196/1	3,1 (3.3)		4.00-8 ① 1,1 km/h (0.7 mph) ② 2,6 km/h (1.6 mph) →	4.00-8 ① 1,1 km/h (0.7 mph) ② 2,6 km/h (1.6 mph) →	A 32 cm (12 in)	37-47-58 cm (15-19-23 in)	111 (245)

G 85d































FORWARD AND COUNTER-ROTATING TILLER



		HP-kW	CC	 L (US qts)		 DIFF. LOCK					 kg (lb)
G 85d	G 300 FA Loncin	HP 9.3 - kW 6.8	302/1	 6,1 (6.4)		✓	 4.00-10	 4.00-10	 A 32 cm (12 in)	 37-47-58-68- 77 cm (15-19-23-27- 30 in)	127 (280)
	GX 270 Honda	HP 8.4 - kW 6.3	270/1	 5,3 (5.6)		✓	 ⓪ 1,3 km/h (0.8 mph)	 ⓪ 1,3 km/h (0.8 mph)			127 (280)
	R 300 D Rato	HP 8.2 - kW 6	301/1	 5,4 (5.7)		✓	 Ⓜ 3,0 km/h (1.9 mph)	 Ⓜ 3,0 km/h (1.9 mph)			142 (313)
	KD15 350 Kohler	HP 7.5 - kW 5.5	349/1	Diesel 4,3 (4.5)		✓	 ⓪ 1,3 km/h (0.8 mph)	 ⓪ 1,3 km/h (0.8 mph)			132 (291)
						✓	 Ⓜ 3,0 km/h (1.9 mph)	 Ⓜ 3,0 km/h (1.9 mph)		151 (332)	

G 107d



		HP-kW	CC 	 L (US qts)		 DIFF. LOCK					 kg (lb)
G 107d	G 300 FA Loncin	HP 9.3 - kW 6.8	302/1	 6,1 (6.4)		✓	 5.00-10	 5.00-10	 A 32 cm (12 in)	 37-47-58-68- 77 cm (15-19-23-27- 30 in)	136 (300)
	GX 270 Honda	HP 8.4 - kW 6.3	270/1	 5,3 (5.6)		✓	 ① 1,3 km/h (0.8 mph) ② 2,4 km/h (1.5 mph) ③ 3,6 km/h (2.2 mph) →	 ① 1,3 km/h (0.8 mph) ② 2,4 km/h (1.5 mph) ③ 3,6 km/h (2.2 mph) →			136 (300)
	R 300 D Rato	HP 8.2 - kW 6	301/1	 5,4 (5.7)		✓	 ① 1,3 km/h (0.8 mph) ② 2,4 km/h (1.5 mph) ③ 3,6 km/h (2.2 mph) ←	 ① 1,3 km/h (0.8 mph) ② 2,4 km/h (1.5 mph) ③ 3,6 km/h (2.2 mph) ←			150 (330)
	KD15 440 Kohler	HP 11 - kW 8.1	441/1	Diesel  5 (5.3)		✓	 ① 1,3 km/h (0.8 mph) ② 2,4 km/h (1.5 mph) ③ 3,6 km/h (2.2 mph) ←	 ① 1,3 km/h (0.8 mph) ② 2,4 km/h (1.5 mph) ③ 3,6 km/h (2.2 mph) ←			168 (370)

G 108 - G 110























G 108

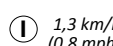
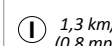

G 110

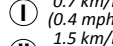
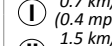

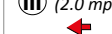
		 CC/HP HP-kW	 DIESEL L (US qts)		 Steering Brakes	 DIFF. LOCK					 kg (lb)
G 108	GX 270 Honda	270 cc/1 HP 8.4 - kW 6.3	 5,3 (5.6)		✓	✓	 5.00-10	 5.00-10			136 (300)
	GX 390 Honda	389 cc/1 HP 11.7 - kW 8.7	 6,1 (6.4)		✓	✓	 I 1,3 km/h (0.8 mph) II 2,4 km/h (1.5 mph) III 4,3 km/h (2.7 mph)	 I 1,3 km/h (0.8 mph) II 2,4 km/h (1.5 mph) III 4,3 km/h (2.7 mph)			144 (317)
G 110	KD15 440 Kohler	441 cc/1 HP 11 - kW 8.1	 Diesel 5 (5.3)		✓	✓	 I 0,7 km/h (0.4 mph) II 1,5 km/h (0.9 mph) III 3,2 km/h (2.0 mph)	 I 0,7 km/h (0.4 mph) II 1,5 km/h (0.9 mph) III 3,2 km/h (2.0 mph)	 A 32 cm (12.6 in)	37-47-58-68-77 cm (15-19-23-27-30 in)	142 (313)
											168 (370)

G 131 - BC



G 131

G 131 BC



G 131 BC



G 131 BC



G 131 BC

		HP-kW	CC/	 L (US qts)		 DIFF. LOCK				 kg (lb)
G 131 BC	Vanguard 16 B&S	HP 14 (16*) kW 10.3	479/2	 8,5 (8.9)		✓	 5.00-12 I 1,2 km/h (0.7 mph) II 2,4 km/h (1.5 mph) III 3,4 km/h (2.1 mph) IV 7.1 km/h (4.4 mph)	 5.00-12 I 1,7 km/h (1.0 mph) II 3,5 km/h (2.2 mph) →	 A 32 cm (12.6 in)	55-70-85 cm (22-28-34 in) 195 (430)
G 131	KD15 440 Kohler	HP 11 - kW 8.1	441 cc/1	 5 (5.3)		✓	 5.00-12 I 1,2 km/h (0.7 mph) II 3,5 km/h (2.2 mph) ←	 5.00-12 I 1,2 km/h (0.7 mph) II 2,4 km/h (1.5 mph) ←	 A 32 cm (12.6 in)	55-70-85 cm (22-28-34 in) 192 (423)

























DUMPER 406



									
Dumper 406	3000 Serie Kohler	HP 5.5 - kW 4.1	196/1			I 1,0 km/h (0.6 mph) II 2,0 km/h (1.2 mph) III 3,5 km/h (2.2 mph)	I 1,0 km/h (0.6 mph) II 2,0 km/h (1.2 mph) III 3,5 km/h (2.2 mph)	400 kg (882 lb)	267 (589)
	GX 200 Honda	HP 5.5 - kW 4.1	196/1						268 (591)

DUMPER 507



									
Dumper 507	GX 270 Honda	HP 8.4 - kW 6.3	270/1	 5,3 (5.6)		 1,0 km/h (0.6 mph)  2,0 km/h (1.2 mph)  3,5 km/h (2.2 mph)  8,7 km/h (5.4 mph)	 1,0 km/h (0.6 mph)  2,0 km/h (1.2 mph)  3,5 km/h (2.2 mph)	500 kg (1102 lb)	302 (666)
	R 300 D Rato	HP 8.2 - kW 6	301/1	 5,4 (5.7)					319 (703)
	KD15 350 Kohler	HP 7.5 - kW 5.5	349/1	 Diesel 4,3 (4.5)					312 (688)
	KD15 350 Kohler	HP 7.5 - kW 5.5	349/1	 Diesel 4,3 (4.5)					337 (743)

HWT 570



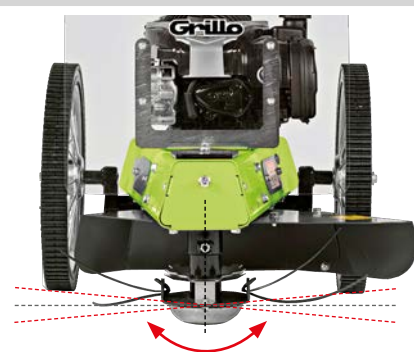







MULTIFORCE



		HP-kW	CC	L (US qts)						kg (lb)
HWT 570 Multiforce	575 EX Honda	HP 3 - kW 2,2	140/1	0,8 (0.8)		--	41 cm (16.2 in)	15-30-50-60 mm (0.6-1.2-2-2.4 in)	60 cm (24 in)	46 (101,4)

HWT 600 WD













										
HWT 600 WD	GCV 170 Honda	HP 4.8 - kW 3.6	166/1	0,9 (1)		2,5 km/h (1.5 mph)	41 cm (16.2 in)	15-30-50-60 mm (0.6-1.2-2-2.4 in)	60 cm (24 in)	47 (104)

HWT 700



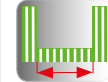





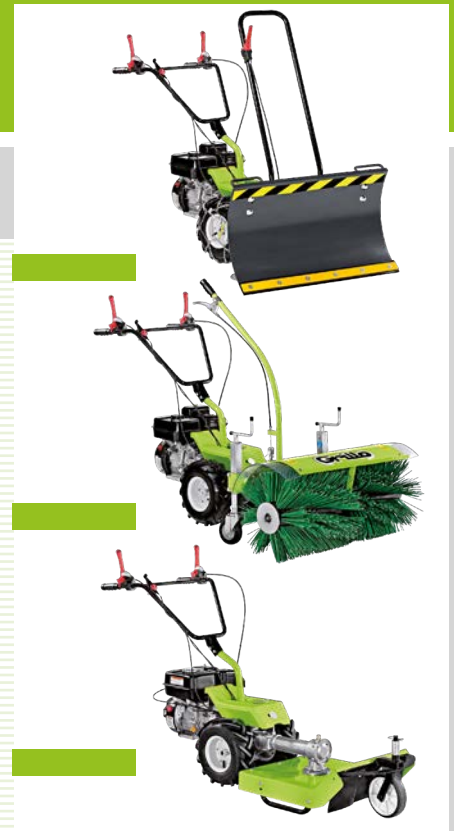

SUPERTRAC



										
		HP-kW	CC	L (US qts)						kg (lb)
HWT 700 SUPERTRAC	<i>Kawasaki</i> FJ180V KAI	HP 4.5 - kW 3.4	179/1	1.7 (1.5)		2,5 km/h (1.5 mph)	38 cm (14.9 in)	15-30-50-60 mm (0.6-1.2-2-2.4 in)	60 cm (24 in)	62 (137)



















GF 1



										
GF 1	G 200 FA Loncin	HP 5.5 - kW 4.1	196/1	3 (3.2) L (US qts)		13x5.00-6	2,20 km/h (1.4 mph)	—	86-96 cm (34-38 in)	70 (154) kg (lb)

GF 2



























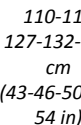

















		HP-kW	 CC	 L (US qts)						 kg (lb)
GF 2	3000 Serie Kohler	HP 5.5 - kW 4.1	196/1	3,6 (3.8)			 4.00-8	 4.00-8	110-115-117 cm (43-45-46 in)	95 (209)
	GX 200 Honda	HP 5.5 - kW 4.1	196/1	3,1 (3.3)			 1,0 km/h (0.6 mph)  2,0 km/h (1.2 mph)  3,0 km/h (1.9 mph)	 1,0 km/h (0.6 mph)  2,0 km/h (1.2 mph)  3,0 km/h (1.9 mph)		96 (212)

GF 3 - GF 3DF



GF 3DF



		HP-kW	 CC	 L (US qts)							 kg (lb)
GF 3	G 300 FA Loncin	HP 9.3 - kW 6.8	302/1	 6,1 (6.4)		-	-	 4.00-8	 4.00-8		110 (242)
	GX 270 Honda	HP 8.4 - kW 6.3	270/1	 5.3 (5.6)		-	-				110 (242)
	KD15 350 Kohler	HP 7.5 - kW 5.5	349/1	 4,3 (4.5)		-	-	 I 1,0 km/h (0.6 mph)	 I 1,0 km/h (0.6 mph)		120 (264)
GF 3DF	G 300 FA Loncin	HP 9.3 - kW 6.8	302/1	 6,1 (6.4)				 II 2,0 km/h (1.2 mph)	 II 2,0 km/h (1.2 mph)		117 (258)
	GX 270 Honda	HP 8.4 - kW 6.3	270/1	 5.3 (5.6)				 III 3,0 km/h (1.9 mph)	 III 3,0 km/h (1.9 mph)		117 (258)
	KD15 350 Kohler	HP 7.5 - kW 5.5	349/1	 4,3 (4.5)							127 (280)

GH 8 - GH 9



GH 8



GH 9













GH 9



GH 9













GH 8

		HP-kW	CC	 L (US qts)						 kg (lb)
GH 8	G 200 FA Loncin	HP 5.5-kW 4.1	196/1	3 (3.2)		HYDROSTATIC 0 - 6 km/h (0 - 3.7 mph) 0 - 3 km/h (0 - 1.9 mph)		20...60 mm (0.78...2.36 in)	58 cm (22.8 in)	135 (297)
GH 9	GX 270 Honda	HP 8.4-kW 6.3	270/1	5,3 (5.6)		HYDROSTATIC 0 - 6 km/h (0 - 3.7 mph) 0 - 3 km/h (0 - 1.9 mph)		30...110 mm (1.2...4.3 in)	68 cm (26.8 in)	158 (348)
						85 cm (33.5 in)	165 (364)			









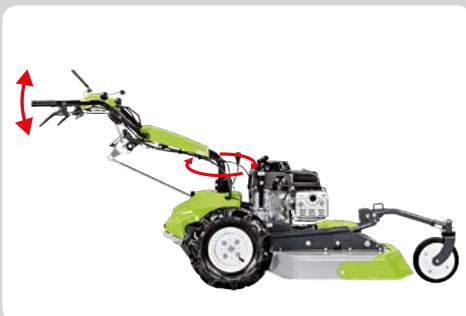

CL 62M



		HP-kW		 L (US qts)						 kg (lb)		
CL 62M	FJ180V Kawasaki	HP 4.5 - kW 3.4	179/1	1,6 (1.5)		HYDROSTATIC		0 - 4,7 km/h (0 - 2.9 mph)	0 - 3 km/h (0 - 1.9 mph)	50...110 mm (2.0...4.3 in)	62 cm (24.4 in)	98 (216)

CL 75



		HP-kW		 L (US qts)							
						DIFF. LOCK	HYDROSTATIC				kg (lb)
CL 75	GXV 390 Honda	HP 10.2 - kW 7.6	389/1	2,1 (2.2)		✓	0 - 6 km/h (0 - 3.7 mph)	0 - 3,5 km/h (0 - 2.2 mph)	50...150 mm (2.0...5.9 in)	75 cm (29.5 in)	140 (309)

CLIMBER 7

7.15 - 7.18



CLIMBER 7.18















CLIMBER 7.18



CLIMBER 7.15



		HP-kW		 L (US qts)	 DIFF. LOCK	 HYDROSTATIC				 kg (lb)
7.15	LC1P92F Loncin	HP 12 (*15) kW 9.2	452/1	 7 (7.4)		0 - 9 km/h (0 - 5.6 mph)	45 cm (18 in)	35...85 mm (1.3...3.3 in)	85 cm (33.5 in)	250 (551)
7.18	INTEK 7180 B&S	HP 15.2 (*18) kW 11.2	656/2	 7 (7.4)		0 - 9 km/h (0 - 5.6 mph)	45 cm (18 in)	35...85 mm (1.3...3.3 in)	85 cm (33.5 in)	255 (562)











CLIMBER 8

8.22



KIT MULCHING



		HP-kW		 L (US qts)						
8.22	7220 Prof. Series B&S	HP 18 (*22) kW 13.2	656/2	 7 (7.4)	 ✓	HYDROSTATIC 0 - 10 km/h (0 - 6.2 mph)	60 cm (23.6 in)	35...110 mm (1.3...4.3 in)	91 cm (36 in)	290 (639)

* Gross Power

CLIMBER 9

9.18 - 9.22



CLIMBER 9.18













CLIMBER 9.22



CLIMBER 9.18











KIT MULCHING

										
	INTEK 7180 B&S	HP15.2 (*18) kW11.2	656/2	13 (13.7)	✓	HYDROSTATIC	38 cm (15 in)	30...90 mm (1.2...3.5 in)	91 cm (36 in)	297 (655)
9.18										
9.22	7220 Prof. Series B&S	HP18 (*22) kW13.2	656/2	13 (13.7)	✓	HYDROSTATIC	38 cm (15 in)	30...90 mm (1.2...3.5 in)	91 cm (36 in)	311 (686)

CLIMBER 9

9.27













		HP-kW		 L (US qts)	 DIFF. LOCK	 HYDROSTATIC			 kg (lb)	
9.27	8270 Commercial Series B&S	HP22 (*27) kW 16.2	724/2	13 (13.7)	✓	0 - 11,5 km/h (0 - 7.1 mph)	70 cm (27.5 in)	35...135 mm (1.4...5.3 in)	98 cm (38 in)	358 (789)

* Gross Power

CLIMBER 10

2WD 27



		HP-kW		 L (US qts)	 DIFF. LOCK	 HYDROSTATIC				 kg (lb)
2WD 27	FS 730V KAWASAKI	HP22 (*27) kW16.2	726/2	 13 (13.7)		0-9,5 km/h (0 - 5.9 mph)	65 cm (25.6 in)	35...135 mm (1.4...5.3 in)	98 cm (38,5 in)	375 (827)

CLIMBER 10

AWD 27- AWD 22



CLIMBER 10 AWD 22



CLIMBER 10 AWD 27











AWD 27



AWD 22



		HP-kW		 L (US qts)	 DIFF. LOCK	 HYDROSTATIC				 kg (lb)
AWD 22	7220 Prof. Series B&S	HP 18 (*22) kW 13.2	656/2	13 (13.7)	✓	0 - 9 km/h (0 - 5.6 mph)	70 cm (27.5 in)	35...135 mm (1.4...5.3 in)	93 cm (36.6 in)	345 (761)
AWD 27	8270 Commercial Series B&S	HP 22 (*27) kW 16.2	724/2	13 (13.7)	✓	0 - 9 km/h (0 - 5.6 mph)	70 cm (27.5 in)	35...135 mm (1.4...5.3 in)	98 cm (38.6 in)	385 (849)

* Gross Power

MD 15-MD 18



MD 18













MD 18



MD 15









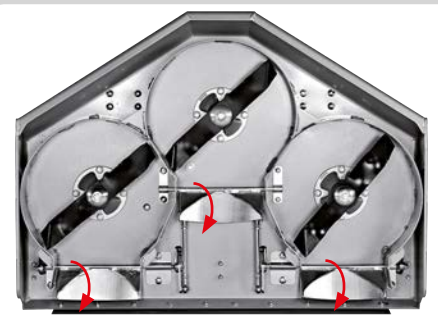

MD 18

		HP-kW		 L (US qts)						 kg (lb)
MD 15	LC1P92F Loncin	HP 12 (*15) kW 9.2	452/1	 7 (7.4)	—	HYDROSTATIC 0 - 9 km/h (0 - 5.6 mph)	45 cm (18 in)	25...75 mm (1.0...3.3 in)	QUICK SHIFT 83 cm (32.6 in)	225 (496)
MD 18	INTEK 7180 B&S	HP 15.2 (*18) kW 11.2	656/2	 7 (7.4)	✓	HYDROSTATIC 0 - 9 km/h (0 - 5.6 mph)	45 cm (18 in)	25...80 mm (1.0...3.5 in)	QUICK SHIFT 83 cm (32.6 in)	238 (525)

MD 22N



		HP-kW		 L (US qts)						
					DIFF. LOCK	HYDROSTATIC		QUICK SHIFT	kg (lb)	
MD 22N	7220 Prof. Series B&S	HP 18 (*22) kW 13.2	656/2	7 (7.4)	✓	0 - 10,5 km/h (0 - 6,5 mph)	48 cm (18.9 in)	25...110 mm (0.9...4.3 in)	110 cm (43 in)	315 (694)

* Gross Power

MD 24 AWD

MD 28 AWD



MD 28 AWD















MD 24 AWD



MD 28 AWD













		HP-kW		 L (US qts)	 DIFF. LOCK	 HYDROSTATIC			 QUICK SHIFT	 kg (lb)
MD 24 AWD	7220 Prof. Series B&S	HP 18 (*22) kW 13.2	656/2	 13 (11.8)		0-9 km/h (0 - 5,6 mph)	70 cm (27.5 in)	25...110 mm (0.9...4.3 in)	110 cm (43 in)	370 (816)
MD 28 AWD	8270 Commercial Series B&S	HP 22 (*27) kW 16.2	724/2	 13 (11.8)		0-9 km/h (0 - 5,6 mph)	70 cm (27.5 in)	25...110 mm (0.9...4.3 in)	130 cm (51 in)	383 (844)

FX 27

Zero-Turn













										
	HP-kW	CC	L (US Gal)		HYDROSTATIC	ZERO TURN	ELECTRIC		kg (lb)	H D W
FX 27	8270 Commercial Series B&S	HP.22 (*27) kW 16.2	724/2	30 (7.9)	0 - 12 km/h (0 - 7.4 mph)		30...85 mm (1.2...3.3 in)	125 cm (49 in)	484 (1067)	H 170 cm D 132 cm W 258 cm

* Gross Power













FD 220R



		HP-kW		 L (US qts)					 kg (lb)	
FD 220R	LC1P92F Loncin	HP 12 (*15) kW 9.2	452/1	 7 (7.4)	HYDROSTATIC 0 - 9 km/h (0 - 5.6 mph)	200 L 5.7 (US bu)	30 cm (11.8 in)	30...90 mm (1.2...3.5 in)	80 cm (31 in)	263 (580)
	VANGUARD 16 B&S	HP 14 (*16) kW 10.3	479/2	 7 (7.4)	HYDROSTATIC 0 - 9 km/h (0 - 5.6 mph)	200 L 5.7 (US bu)	30 cm (11.8 in)	30...90 mm (1.2...3.5 in)	80 cm (31 in)	270 (595)
										H 114 cm D 86 cm W 234 cm

FD 280



		HP-kW		 L (US qts)								
					DIFF. LOCK	HYDROSTATIC	ELECTRIC				kg (lb)	H D W
FD 280	VANGUARD 16 B&S	HP 14 (*16) kW10.3	479/2			0-9,5 km/h (0-5.9 mph)	280 L 8 (US bu)	30 cm (11.8 in)	30...90 mm (1.2...3.5 in)	113 cm (44 in)	320 (705)	H 120 cm D 119 cm W 238 cm

* Gross Power

FD 450













Kit Mulching

FD 450	7220 Prof. Series B&S	HP 18 (*22) kW 13.2	656/2	17 (4.5)	✓	HYDROSTATIC	HYDRAULIC	HYDRAULIC	ELECTRIC	113 cm (44 in)	450 (992)	H ¹ 194 cm H 146 cm D 119 cm W 268 cm
				L (US Gal)	DIFF. LOCK	0 - 11 km/h (0 - 6.8 mph)	450 L 12.8 (US bu)	30 cm (11.8 in)	25...90 mm (1.0...3.5 in)			

FD 500













		HP-kW		 L (US Gal)	 DIFF. LOCK					 kg (lb)		
FD 500	D 722 E4B Kubota STAGE 5	HP 18 - kW 13.2	722/3	Diesel 22 (5.8)		0 - 13 km/h (0 - 8 mph)	700 L 19.8 (US bu)	32 cm (12.5 in)	25....90 mm (0.9...3.5 in)	113 cm (44.4 in)	630 (1388)	H ¹ 193 cm H 151 cm D 119 cm W 271 cm

FD 900

4WD















		HP-kW		 L (US Gal)	 DIFF. LOCK	 HYDROSTATIC	 HYDRAULIC	 HYDRAULIC	 HYDRAULIC		 kg (lb)	
FD 900 4WD	3TNV80F Yanmar STAGE 5	HP 25 - kW 18.4	1267/3	Diesel 31 (8.2)	✓	0 - 15 km/h (0 - 9 mph)	750 L 21.3 (US bu)	37 cm (14.6 in)	20...100 mm (0.8...3.9 in)	126 cm (49.6 in)	980 (2160)	H ¹ 207 cm H 166 cm D 133 cm W 291 cm

FD 13.09

4WD













													
FD 13.09 4WD	3TNV82A Yanmar STAGE 5	HP 26 - kW 18.9	1331/3	Diesel 23 (6.0)	✓	0 - 15 km/h (0 - 9.3 mph)	900 L 25.5 (US bu)	31 cm (12 in)	HYDRAULIC	20...100 mm (0.8...3.9 in)	132 cm (52 in)	1230 (2712)	H ¹ 213 cm H 175 cm D 141 cm W 325 cm
									HYDRAULIC	20...120 mm (0.8...4.7 in)	155 cm (61 in)	1310 (2888)	H ¹ 213 cm H 175 cm D 162 cm W 340 cm

FD 2200

4WD















		HP-kW		 L (US Gal)	 DIFF. LOCK	 HYDROSTATIC	 HYDRAULIC	 HYDRAULIC			 kg (lb)	
FD 2200 4WD	3TNV88C Yanmar STAGE 5	HP 37 kW 27.5	1642/3	Diesel 50 (13.2)	✓	0 - 20 km/h (0 - 12.4 mph)	1200 L 34 (US bu)	62 cm (24 in)	25...110 mm (0.9...4.3 in)	155 cm (61 in)	1468 (3236)	H ⁺ 243cm H 183 cm D 162 cm W 347 cm

FD 2200 TS

4WD













		HP-kW		 L (US Gal)	 DIFF. LOCK	 HYDROSTATIC	 HYDRAULIC	 HYDRAULIC	 HYDRAULIC	 HYDRAULIC	 kg (lb)	
FD 2200 TOP SCORER 4WD	4TNV88C Yanmar STAGE 5	HP 47 kW 34.3	2190/4	Diesel  50 (13.2)		0 - 21 km/h (0 - 13.6 mph)	1400 L 39.7 (US bu)	60 cm (24 in)	20...120 mm (0.8...4.7 in)	155 cm (61 in)	1656 (3651)	H ¹ 231cm H 199 cm D 162 cm W 364 cm
										180 cm (71 in)		1705 (3758)

FM 13.09

4WD















		HP-kW		 L (US Gal)	 DIFF. LOCK	 HYDROSTATIC		 HYDRAULIC			 kg (lb)	
FM 13.09 4WD	3TNV82A Yanmar STAGE 5	HP26 - kW18.9	1331/3	Diesel 23 (6.0)	✓	0 - 15 km/h (0 - 9.3 mph)	12000 m ² /h	31 cm (12 in)	20...100 mm (0.8...3.9 in)	160 cm (63 in)	1150 (2535)	H ⁺ 213 cm H 175 cm D 192 cm W 325 cm

FM 2200

4WD



												
	HP-kW	CC	L (US Gal)	DIFF. LOCK	HYDROSTATIC		HYDRAULIC				kg (lb)	
FM 2200 4WD	3TNV88C Yanmar STAGE 5	HP 37 kW 27.5	1642/3	Diesel 50 (13.2)	✓	0 - 20 km/h (0 - 12.4 mph)	15500 m ² /h	62 cm (24 in)	20...90 mm (0.8...3.5 in)	160 cm (63 in)	1322 (2915)	H ¹ 231cm H 199 cm D 192 cm W 342 cm



Nell'ottica di un costante sviluppo dei propri prodotti, Grillo Spa si riserva il diritto di cambiare le specifiche tecniche e le illustrazioni su questo documento in qualsiasi momento e senza preavviso né obbligo. Foto e caratteristiche non contrattuali. In the pursuit of constant development of his products, Grillo Spa reserves for himself the right to change the technical specifications and the illustrations on this document, at any given moment and without notice and without any kind of obligation. All the pictures characteristics are not contract-binding. En poursuivant une politique constante d'amélioration de ses produits, Grillo Spa se réserve le droit de modifier les spécifications techniques en tout temps sans préavis ni obligation. Photographies et caractéristiques non contractuelles. Aufgrund ständiger Weiterentwicklung behält sich Grillo Spa Änderungen in Form, Technik und Ausstattung der Produktpalette vor. Aus Angaben und Abbildungen des vorliegenden Grillo-Katalogs können keine Ansprüche abgeleitet werden. En vista de un desarrollo constante de sus productos, Grillo Spa se reserva el derecho de cambiar las especificaciones técnicas y las ilustraciones mostradas en este documento en cualquier momento y sin aviso previo. Las fotos y características no son contractuales.



www.grillospa.it
 e-mail: grillo@grillospa.it
 Tel. (0039) 0547.633111
 Fax (0039) 0547.632011

www.grillofrance.fr
www.grillodeutschland.de
www.grilloagrigarden.co.uk
www.grilloaustralia.com.au
www.grilloagrigarden.ru